

Wrenches

Adjustable Wrenches, Combination Wrenches, Ring Wrenches, Open End Wrenches...

Adjustable Wrench

Cr-V
NON-SLIP

Optimized contact surfaces for maximum user comfort.



Contoured handle for improved handling.

Millimetre graduations for pre-setting jaw opening.



Plastic Card

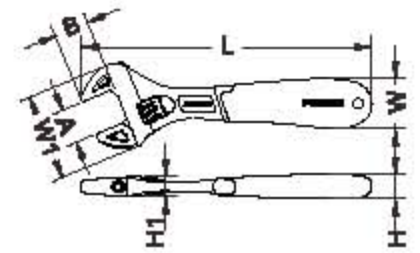

No.	Size	H min	H1 max	L max	W min	W1 min	A min	B min	g	g
B0101	6"	13.5	8.8	158	28	45	19.5	18.5	140.0	6/120
B0102	8"	17	11.3	208	35	55	24.6	24	270.0	6/72
B0103	10"	20.5	14	258	42	68	30.5	28.5	440.0	6/54

Adjustable Wrench

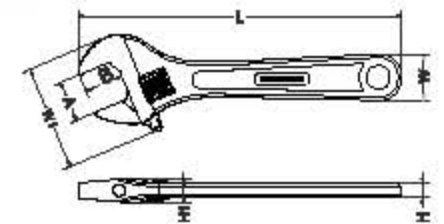

No.	Size	H min	H1 max	L max	W min	W1 min	A min	B min	g	g
B0104	6"	5.2	11.3	160	16.3	50.6	16.8	20.6	125	12/120
B0105	8"	8.8	13.4	200	24	65	24.9	24.8	255	12/72
B0106	10"	7.8	15.8	250	27.5	77	30.5	30.5	405	12/48
B0107	12"	8	18.9	300	30.8	81	37	36.3	635	6/36
B0108	15"	10	26	375	38	112	45	42	1450	6/24
B0109	18"	11.1	28.7	450	42.2	138.5	50.8	53	1940	6/12



Sliding Card
(B0104-B0106)



Color Label
(B0107-B0109)

Combination Wrench

Cr-V
DIN 3113
MICRO FINISH

12-point profile for a high torque without damaging.



Optimized open end/handle geometry for increased accessibility.

Unique non-slip textured design.

Color Label

No.	Size	H1 mm	H2 mm	L mm	W1 mm	W2 mm	g	📦
B0201	6mm	4.6	5.5	110	14.5	11	22.0	6/120
B0202	7mm	4.6	5.5	120	16	12	24.0	6/120
B0203	8mm	5	6	130	18.5	13.5	26.0	6/120
B0204	9mm	5.5	6.5	140	20.5	15	34.0	6/120
B0205	10mm	5.5	6.5	150	22.5	16	43.0	6/120
B0206	11mm	6	7	160	24	18	48.0	6/120
B0207	12mm	6	8	170	26.5	19	63.0	6/120
B0208	13mm	6	8.5	180	28	20.5	72.0	6/120
B0209	14mm	6	8.5	190	30.5	22	68.0	6/120
B0210	15mm	7	9	200	32	23.5	101.0	6/120
B0211	16mm	7	10	210	35	25	106.0	6/120
B0212	17mm	7.5	10	220	37	26	126.0	6/120
B0213	18mm	7.5	10.5	230	39	27.5	145.0	6/120
B0214	19mm	8	11	240	41	28.5	167.0	6/80
B0215	20mm	8	11	250	42	29	190.0	6/80
B0216	21mm	8	11.5	260	44	31	224.0	6/80
B0217	22mm	8.5	11.5	270	46	32.5	228.0	6/80
B0218	23mm	8.5	12	280	48	34.5	261.0	6/80
B0219	24mm	9	12.5	290	50.5	35	281.0	6/80
B0220	26mm	9.5	13	310	54	38	313.0	6/48
B0221	27mm	9.5	13	320	56.5	39	283.0	6/48
B0222	28mm	10	14.5	330	56.5	40.5	430.0	6/48
B0223	29mm	10	14.5	340	60	42	470.0	6/48
B0224	30mm	10	15.5	350	62	44	512.0	6/48
B0225	32mm	11	16	370	66	46	522.0	6/36



Double Ring Wrench

Cr-V
DIN 838
MICRO FINISH



Color Label

No.	Size	H1 mm	H2 mm	L mm	W1 mm	W2 mm	g	📦
B0301	6x7mm	6.5	8	170	11	12.5	60.0	6/120
B0302	8x9mm	6	8.5	180	14	15.5	60.0	6/120
B0303	10x11mm	7.5	8	200	17	18.5	66.0	6/120
B0304	12x13mm	8	8.5	220	20	21	102.0	6/120
B0305	14x16mm	9.5	10	235	22.5	24	138.0	6/120
B0306	16x17mm	10	10.5	255	25.5	25.5	184.0	6/120
B0307	18x19mm	10.5	11	270	28	28.5	205.0	6/80
B0308	20x22mm	11.5	12	290	30.5	34	263.0	6/48
B0309	24x27mm	13	14	325	35.5	40.5	503.0	6/48
B0310	30x32mm	15	16	360	44	47	747.0	6/36

Double Open End Wrench

Cr-V
DIN 3110
MICRO FINISH

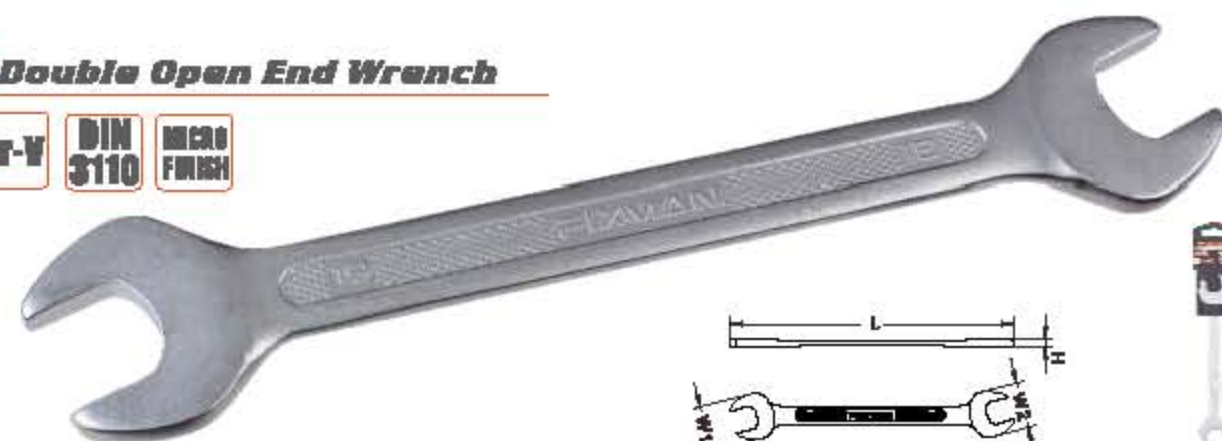

Plastic Hanger

No.	Size	L mm	H mm	W1 mm	W2 mm	g	📦
B0401	6x7mm	121	4	16	17	27.0	6/120
B0402	8x9mm	140	4.5	19	22	42.0	6/120
B0403	10x11mm	156	5	23	26	63.0	6/120
B0404	12x13mm	171	5.5	27	30	83.0	6/120
B0405	14x16mm	180	6	30	33	106.0	6/120
B0406	16x17mm	201	6.5	35	38	142.0	6/120
B0407	18x19mm	221	7.5	38	42	175.0	6/120
B0408	20x22mm	235	7.5	43	48	220.0	6/60
B0409	24x27mm	281	8.5	53	58	360.0	6/48
B0410	30x32mm	298	9	63	67	620.0	6/36

T-type Socket Wrench

GT-T

No.	Size	W mm	L mm	kg	Box/Pack
B1001	8mm	200	305	280	6/48
B1002	10mm	200	305	285	6/48
B1003	12mm	200	305	300	6/48
B1004	17mm	200	305	350	6/48
B1005	19mm	200	305	365	6/48

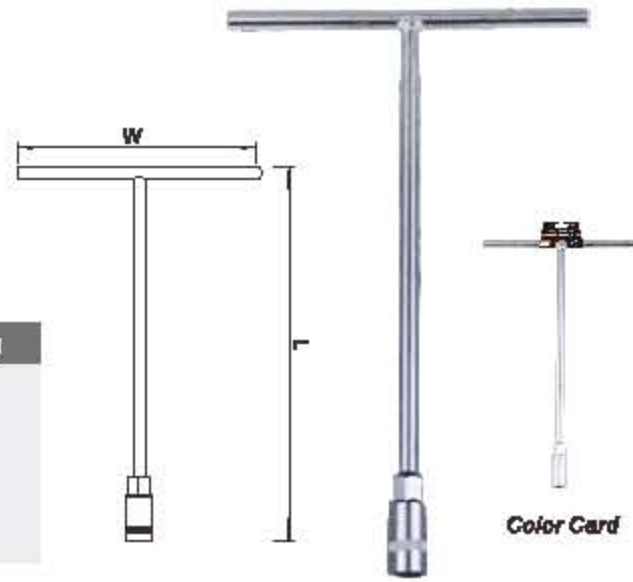

Wrench Set



No.	Name	Contents	Box/Pack
B0907	8-PC Combination Wrench	8, 10, 11, 12, 13, 14, 15, 17, 19mm	1/24
B0908	11-PC Combination Wrench	8, 9, 10, 11, 12, 13, 14, 15, 17, 19, 22mm	1/12
B0909	14-PC Combination Wrench	8, 9, 10, 11, 12, 13, 14, 15, 16, 17, 18, 19, 22, 24mm	1/12
B0910	23-PC Combination Wrench	8, 7, 8, 9, 10, 11, 12, 13, 14, 15, 16, 17, 18, 19, 20, 21, 22, 23, 24, 25, 27, 30, 32mm	1/8
B0911	8-PC Double Ring Wrench	8x8, 10x11, 12x13, 14x15, 16x17, 18x19mm	1/24
B0912	8-PC Double Ring Wrench	6x7, 8x9, 10x11, 12x13, 14x15, 16x17, 18x19, 20x22mm	1/12
B0913	10-PC Double Ring Wrench	6x7, 8x9, 10x11, 12x13, 14x15, 16x17, 18x19, 20x22, 24x27, 30x32mm	1/8
B0914	8-PC Double Open End Wrench	8x8, 10x11, 12x13, 14x15, 16x17, 18x19mm	1/24
B0915	8-PC Double Open End Wrench	6x7, 8x9, 10x11, 12x13, 14x15, 16x17, 18x19, 20x22mm	1/24
B0916	10-PC Double Open End Wrench	6x7, 8x9, 10x11, 12x13, 14x15, 16x17, 18x19, 20x22, 24x27, 30x32mm	1/12



Screwdrivers

Screwdrivers, Hex Key, Bits, Precision Screwdrivers...



- Chrome vanadium steel blade, through hardened. Magnetic tip. Fine finished by satin chrome. TPR two tone handle, soft and heavy duty.
- The handle with triangular cross-section for optimum torque transfer and anti-roll protection.
- The ergonomic features of series OMC optimised handles for increased comfort.
- The unified LOGO section, to achieve a better and longer presentation.



Screwdriver

Screwdriver-Slotted

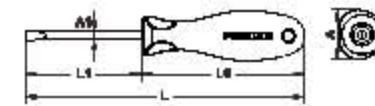

No.	Size	L mm	L0 mm	L1 mm	A mm	A1 mm	g	Box/Pack
D0101	3x0.6x75mm	150	75	75	21.4	3	25.0	6/120
D0102	4x0.8x100mm	175	75	100	21.4	4	60.0	6/120
D0103	5.5x1x75mm	175	100	75	26.5	5	60.0	6/120
D0104	5.5x1x100mm	200	100	100	26.5	5	65.0	6/120
D0105	6.5x1.2x85mm	100	65	35	34	6	55.0	6/96
D0108	6.5x1.2x100mm	213	113	100	34	6	100.0	6/96
D0107	6.5x1.2x125mm	238	113	125	34	6	105.0	6/96
D0108	6.5x1.2x150mm	263	113	150	34	6	135.0	6/96
D0109	8x1.2x150mm	275	125	150	37.8	8	165.0	6/72
D0110	8x1.2x200mm	325	125	200	37.8	8	180.0	6/72
D0111	6.5x1.2x200mm	313	113	200	34	6	150.0	6/72
D0112	6.5x1.2x250mm	363	113	250	34	6	165.0	6/72
D0113	6.5x1.2x300mm	413	113	300	34	6	180.0	6/72
D0114	8x1.2x250mm	375	125	250	34	8	195.0	6/72
D0115	8x1.2x300mm	425	125	300	37.8	8	210.0	6/72



Plastic Card

Screwdriver-Phillips

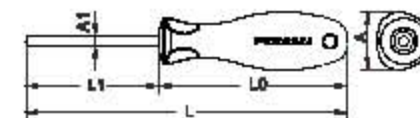

No.	Size	L mm	L0 mm	L1 mm	A mm	A1 mm	g	Box/Pack
D0201	PH0X75mm	150	75	75	21	3	25.0	6/120
D0202	PH1X75mm	175	100	75	28	5	60.0	6/120
D0203	PH1X100mm	200	100	100	28	5	65.0	6/120
D0204	PH1X125mm	225	100	125	28	6	70.0	6/120
D0205	PH2X38mm	100	65	35	34	6	55.0	6/96
D0206	PH2X100mm	213	113	100	34	6	100.0	6/96
D0207	PH2X125mm	238	113	125	34	6	105.0	6/96
D0208	PH3X150mm	263	113	150	34	6	135.0	6/96
D0209	PH2X150mm	275	125	150	34	8	160.0	6/72
D0210	PH3X200mm	325	125	200	38	8	180.0	6/72
D0211	PH4X200mm	325	125	200	38	8	185.0	6/72
D0212	PH2X200mm	313	113	200	34	8	150.0	6/72
D0213	PH2X250mm	363	113	250	34	6	165.0	6/72
D0214	PH2X300mm	413	113	300	34	6	180.0	6/72
D0215	PH3X250mm	375	125	250	38	8	195.0	6/72
D0216	PH3X300mm	425	125	300	38	8	210.0	6/72



Plastic Card

Screwdriver-Pozy

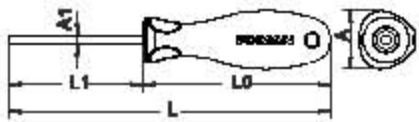

Plastic Card

No.	Size	L mm	L0 mm	L1 mm	A mm	A1 mm	g	Box/Case
D0301	PZ1X75mm	175	100	75	20	5	29	6/120
D0302	PZ2X100mm	213	113	100	34	8	34	6/96
D0303	PZ3X150mm	275	125	150	38	8	38	6/72

Screwdriver-Torx

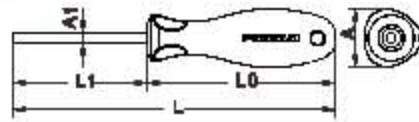

Plastic Card

No.	Size	L mm	L0 mm	L1 mm	A mm	A1 mm	g	Box/Case
D0401	T10X100mm	175	100	100	20	5	60.0	6/96
D0402	T15X100mm	213	113	100	34	5	100.0	6/96
D0403	T20X100mm	213	113	100	34	5	100.0	6/96
D0404	T25X100mm	213	113	100	34	5	100.0	6/96
D0405	T27X100mm	213	113	100	34	5	100.0	6/96
D0406	T30X100mm	213	113	100	34	5	100.0	6/96
D0407	T40X100mm	225	125	100	38	5	160.0	6/72

Screwdriver Set



No.	Name	Contents	
D1801	8pcs screwdriver set	6.5x1.2x38mm, 4x0.8x100mm, 5.5x1.0x100mm, 6.5x1.2x150mm, PH1x100mm, PH2x38mm, PH3x160mm, PH2x100mm	1
D1802	7pcs screwdriver set	6.5x1.2x38mm, 3x0.8x75mm, 4x0.8x100mm, 5.5x1.0x100mm, 6.5x1.2x100mm, 6.5x1.2x150mm, 6x1.2x200mm	2
D1803	7pcs screwdriver set	PH2x38mm, PH0x75mm, PH1x100mm, PH2x125mm, PH3x150mm, PH4x200mm, PH2x100mm	3
D1804	7pcs screwdriver set	T10x100mm, T15x100mm, T20x100mm, T25x100mm, T27x100mm, T30x100mm, T40x100mm	4
D1805	7pcs screwdriver set	4x0.8x100mm, 6.5x1.2x100mm, 6x1.2x150mm, PH1x100mm, PH2x100mm, T20x100mm, T25x100mm	
D1806	8pcs screwdriver set	4x0.8x100mm, 5.5x1.0x100mm, 6.5x1.2x150mm, 6x1.2x200mm, PH0x75mm	
D1806	8pcs screwdriver set	PH1x100mm, PH2x125mm, PH3x160mm	
D1807	7pcs Impact screwdriver set	4x0.8x100mm, 5.5x1.0x100mm, 6.5x1.2x125mm, 6x1.2x150mm, 10x1.2x175mm	
D1807	screwdriver set	PH2x100mm, PH3x150mm	
D1808	7pcs screwdriver set	3x0.8x75mm, 5.5x1.0x75mm, 6.5x1.2x125mm, 6x1.2x150mm, PZ1x75mm, PZ2x100mm, PZ3x150mm	5

Impact Screwdriver

Impact Screwdriver-Slotted

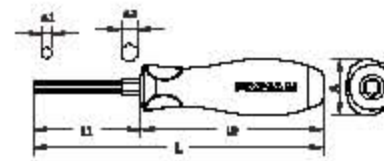

No.	Size	L mm	L0 mm	L1 mm	A mm	A1 mm	A2 mm	g	Box/Case
D0801	3.6x0.6x75mm	175	100	75	26.5	4	10	35.0	6/96
D0802	4.5x1.0x80mm	180	100	80	28.5	5	8	55.0	6/96
D0803	6.5x1.0x100mm	200	100	100	28.5	5	10	70.0	6/96
D0803	6.5x1.2x125mm	225	100	125	28.5	5	10	115.0	6/85
D0804	8.0x1.2x150mm	250	110	150	34	8	13	170.0	6/85
D0805	10.0x1.6x175mm	285	110	175	34	8	13	185.0	6/85



Half Double Blister

Impact Screwdriver-Pozy

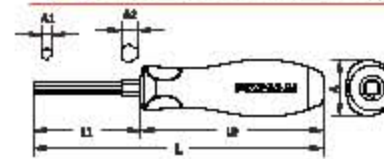

No.	Size	L mm	L0 mm	L1 mm	A mm	A1 mm	A2 mm	g	Box/Case
D1801	PZ1x80mm	180	100	80	29	5	8	75.0	6/96
D1802	PZ2x100mm	200	100	100	29	5	10	95.0	6/96
D1803	PZ3x150mm	250	110	150	34	8	13	115.0	6/96
D1804	PZ4x200mm	310	110	200	34	9.5	14	170.0	6/96



Half Double Blister

Impact Screwdriver-Phillips

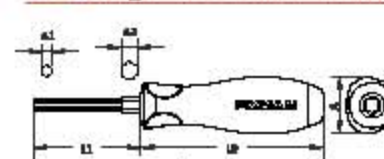

No.	Size	L mm	L0 mm	L1 mm	A mm	A1 mm	A2 mm	g	Box/Case
D0901	PH1X80mm	180	100	80	29	5	8	75.0	6/96
D0902	PH2X100mm	200	100	100	29	5	10	105.0	6/96
D0903	PH3X150mm	250	110	150	34	8	13	170.0	6/96



Half Double Blister

Impact Screwdriver-Torx

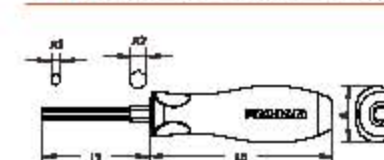

No.	Size	L mm	L0 mm	L1 mm	A mm	A1 mm	A2 mm	g	Box/Case
D1701	T15x80mm	180	100	80	29	5	8	75.0	6/96
D1702	T20x90mm	180	100	90	29	8	10	95.0	6/96
D1703	T25x100mm	200	100	100	29	8	10	115.0	6/96
D1704	T27x125mm	225	100	125	29	8	10	130.0	6/96
D1705	T30x150mm	250	100	150	29	8	10	170.0	6/96
D1706	T40x150mm	280	110	150	34	8	13	175.0	6/96



Half Double Blister

Bit Driver

Ratchet Screwdriver-Straight Head

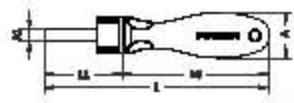

Plastic Card



No.	Size	L mm	L0 mm	L1 mm	A mm	A1 mm	g	📦/🚚
D0801	1/4"Dr.	175	110	62.5	33	10.5	145.0	8/72

Ratchet Screwdriver-3 Way Head

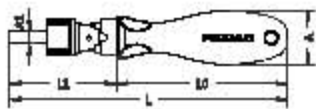

Plastic Card



No.	Size	L mm	L0 mm	L1 mm	A mm	A1 mm	g	📦/🚚
D0801	1/4"Dr.	185	112	73	34	12	185.0	8/72

Bit Holder Screwdriver

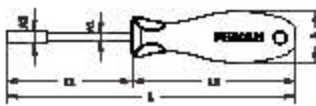

Plastic Card



No.	Size	L mm	L0 mm	L1 mm	A mm	A1 mm	A2 mm	g	📦/🚚
D0701	1/4"Dr., 6X100mm	215	112	100	33	5.84	9.8	105.0	8/72



1/4"Dr./6.3mm Bits

25mm(L) Bits



No.	Size	g	📦/🚚
N3000	SL3	4	24/144
N3001	SL4	4	24/144
N3002	SL5.5	8	24/144
N3003	SL6.5	9	24/144
N3004	SL7	9	24/144
N3201	PH0	3	24/144
N3202	PH1	4	24/144
N3203	PH2	8	24/144
N3204	PH3	9	24/144
N3401	T8	3	24/144
N3402	T10	4	24/144
N3403	T16	8	24/144
N3404	T20	8	24/144
N3405	T27	13	24/144
N3406	T30	15	24/144
N3407	T40	17	24/144
N3408	T25	11	24/144
N3601	PZ0	3	24/144
N3602	PZ1	4	24/144
N3603	PZ2	8	24/144
N3604	PZ3	9	24/144
N4801	H2	3	24/144
N4802	H3	4	24/144
N4803	H4	8	24/144
N4804	H5	9	24/144
N4805	H6	11	24/144

50mm(L) Bits



No.	Size	g	📦/🚚
N3100	SL3	9	24/144
N3101	SL4	9	24/144
N3102	SL5.5	11	24/144
N3103	SL6.5	13	24/144
N3104	SL7	13	24/144
N3301	PH0	6	24/144
N3302	PH1	9	24/144
N3303	PH2	11	24/144
N3304	PH3	13	24/144
N3501	T8	8	24/144
N3502	T10	9	24/144
N3503	T15	11	24/144
N3504	T20	13	24/144
N3505	T27	17	24/144
N3506	T30	21	24/144
N3507	T40	23	24/144
N3608	T25	15	24/144
N3701	PZ0	6	24/144
N3702	PZ1	9	24/144
N3703	PZ2	11	24/144
N3704	PZ3	13	24/144
N4901	H2	8	24/144
N4902	H3	9	24/144
N4903	H4	11	24/144
N4904	H5	13	24/144
N4905	H6	15	24/144

75mm(L) Bits

S2 **INDEL PLATED** **10 PCS**



No.	Size	g	24/96
N4201	SL3	11.0	24/96
N4202	SL4	13.0	24/96
N4203	SL5.5	15.0	24/96
N4204	SL6.5	17.0	24/96
N4205	SL7	21.0	24/96
N3801	PH2	15.0	24/96
N3802	PH0	11.0	24/96
N3803	PH1	13.0	24/96
N3804	PH3	17.0	24/96
N4001	PZ0	11.0	24/96
N4002	PZ1	13.0	24/96
N4003	PZ2	15.0	24/96
N4004	PZ3	17.0	24/96
N4401	T8	11.0	24/96
N4402	T10	13.0	24/96
N4403	T15	15.0	24/96
N4404	T20	17.0	24/96
N4405	T25	21.0	24/96
N4406	T27	23.0	24/96
N4407	T30	25.0	24/96
N4408	T40	27.0	24/96
N4601	H2	11.0	24/96
N4602	H3	13.0	24/96
N4603	H4	15.0	24/96
N4604	H5	17.0	24/96
N4605	H6	21.0	24/96

100mm(L) Bits

S2 **INDEL PLATED** **10 PCS**

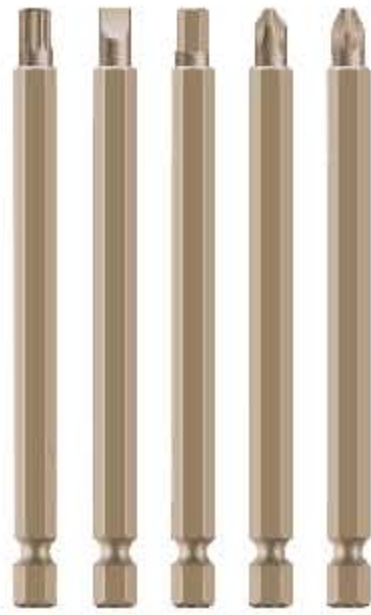

No.	Size	g	24/96
N4301	SL3	17.0	24/96
N4302	SL4	21.0	24/96
N4303	SL5.5	23.0	24/96
N4304	SL6.5	25.0	24/96
N4305	SL7	27.0	24/96
N3901	PH2	23.0	24/96
N3902	PH0	17.0	24/96
N3903	PH1	21.0	24/96
N3904	PH3	25.0	24/96
N4101	PZ0	17.0	24/96
N4102	PZ1	21.0	24/96
N4103	PZ2	23.0	24/96
N4104	PZ3	25.0	24/96
N4501	T8	17.0	24/96
N4502	T10	21.0	24/96
N4503	T15	23.0	24/96
N4504	T20	25.0	24/96
N4505	T25	27.0	24/96
N4506	T27	29.0	24/96
N4507	T30	31.0	24/96
N4508	T40	33.0	24/96
N4701	H2	17.0	24/96
N4702	H3	21.0	24/96
N4703	H4	23.0	24/96
N4704	H5	25.0	24/96
N4705	H6	27.0	24/96

D1809 21-pc Bits & Screwdriver Set

No.	Contents	24/96
1x Bit Holder Screwdriver	1/4" Dr.x100mm	
20x 1/4" Dr. 25mm(L) Bits	ADA, PH0-1-2-3, SL4-5-5, PZ1-2, T10-15-20-25-27-30-40, S0-1-2	6/72



Precision Screwdriver

Precision Screwdriver Set



No.	Contents	24/96
L1301	PH000-PH00-PH0-PH1	6/120
L1302	H0.7-H0.9-H1.3-H1.5	6/120
L1303	SL1.5-SL2.0-SL2.5-SL3.0	6/120
L1304	PH0-PH0-SL1.5-SL2.0-SL2.5-SL3.0	6/120
L1305	PH0-PH1-SL1.5-SL2.0-SL2.5-SL3.0	6/120
L1306	T5-T6-T7-T8-T9-T10	6/120

Precision Screwdriver Set



No.	Contents	24/96
L1307	PH000-PH00-PH0-PH1	6/120
L1308	H0.7-H0.9-H1.3-H1.5	6/120
L1309	SL1.5-SL2.0-SL2.5-SL3.0	6/120
L1310	PH0-PH0-SL1.5-SL2.0-SL2.5-SL3.0	6/120
L1311	PH0-PH1-SL1.5-SL2.0-SL2.5-SL3.0	6/120
L1312	T5-T6-T7-T8-T9-T10	6/120





Keys

Hex & Torx Key Set



No.	Size	g	Box/Pack
D2201	H1.5-H2-H2.5-H3-H4-H5-H5.5-H6	140	6/120
D2202	H5/64-H3/32-H1/8-H9/84-H5/32-H3/16-H7/32-H1/4	140	6/120
D2203	T10-T16-T20-T25-T27-T30-T40	140	6/120



Double Bilster

Torx Key Set



No.	Name	Contents	Box/Pack
D2325	9-PC Standard Long Torx Keys Set	T10-T15-T20-T25-T27-T30-T40-T45-T50	6/36
D2326	9-PC Medium Long Torx Keys Set	T10-T15-T20-T25-T27-T30-T40-T45-T50	6/36
D2327	9-PC Extra Long Torx Keys Set	T10-T15-T20-T25-T27-T30-T40-T45-T50	6/24
D2328	9-PC Standard Long Reaktorx Keys Set	T10H-T15H-T20H-T25H-T27H-T30H-T40H-T45H-T50H	6/36
D2329	9-PC Medium Long Reaktorx Keys Set	T10H-T15H-T20H-T25H-T27H-T30H-T40H-T45H-T50H	6/36
D2330	9-PC Extra Long Reaktorx Keys Set	T10H-T15H-T20H-T25H-T27H-T30H-T40H-T45H-T50H	6/24



Double Bilster

Hex Key Set



No.	Name	Contents	Box/Pack
D2301	10-PC Standard Long Sae Hex Keys Set	1/16-5/64-3/32-1/8-5/32-3/16-1/4-5/16-3/8-1/2	6/36
D2302	9-PC Standard Long Sae Hex Keys Set	1/16-5/64-3/32-1/8-5/32-3/16-1/4-5/16-3/8	6/36
D2303	10-PC Standard Long Metric Hex Keys Set	1.5-2-2.5-3-4-5-6-8-10-12mm	6/36
D2304	9-PC Standard Long Metric Hex Keys Set	1.5-2-2.5-3-4-5-6-8-10mm	6/36
D2321	10-PC Medium Long Sae Hex Keys Set	1/16-5/64-3/32-1/8-5/32-3/16-1/4-5/16-3/8-1/2	6/36
D2317	9-PC Medium Long Sae Hex Keys Set	1/16-5/64-3/32-1/8-5/32-3/16-1/4-5/16-3/8	6/36
D2322	10-PC Medium Long Metric Hex Keys Set	1.5-2-2.5-3-4-5-6-8-10-12mm	6/36
D2318	9-PC Medium Long Metric Hex Keys Set	1.5-2-2.5-3-4-5-6-8-10mm	6/36
D2305	10-PC Extra Long Sae Hex Keys Set	1/16-5/64-3/32-1/8-5/32-3/16-1/4-5/16-3/8-1/2	6/24
D2308	9-PC Extra Long Sae Hex Keys Set	1/16-5/64-3/32-1/8-5/32-3/16-1/4-5/16-3/8	6/24
D2307	10-PC Extra Long Metric Hex Keys Set	1.5-2-2.5-3-4-5-6-8-10-12mm	6/24
D2309	9-PC Extra Long Metric Hex Keys Set	1.5-2-2.5-3-4-5-6-8-10mm	6/24



Double Bilster

Hex Key Set with Ball Head



No.	Name	Contents	Box/Pack
D2309	10-PC Standard Long Sae Hex Keys Set	1/16-5/64-3/32-1/8-5/32-3/16-1/4-5/16-3/8-1/2	6/36
D2310	9-PC Standard Long Sae Hex Keys Set	1/16-5/64-3/32-1/8-5/32-3/16-1/4-5/16-3/8	6/36
D2311	10-PC Standard Long Metric Hex Keys Set	1.5-2-2.5-3-4-5-6-8-10-12mm	6/36
D2312	9-PC Standard Long Metric Hex Keys Set	1.5-2-2.5-3-4-5-6-8-10mm	6/36
D2323	10-PC Medium Long Sae Hex Keys Set	1/16-5/64-3/32-1/8-5/32-3/16-1/4-5/16-3/8-1/2	6/36
D2319	9-PC Medium Long Sae Hex Keys Set	1/16-5/64-3/32-1/8-5/32-3/16-1/4-5/16-3/8	6/36
D2324	10-PC Medium Long Metric Hex Keys Set	1.5-2-2.5-3-4-5-6-8-10-12mm	6/36
D2320	9-PC Medium Long Metric Hex Keys Set	1.5-2-2.5-3-4-5-6-8-10mm	6/36
D2313	10-PC Extra Long Sae Hex Keys Set	1/16-5/64-3/32-1/8-5/32-3/16-1/4-5/16-3/8-1/2	6/24
D2314	9-PC Extra Long Sae Hex Keys Set	1/16-5/64-3/32-1/8-5/32-3/16-1/4-5/16-3/8	6/24
D2315	10-PC Extra Long Metric Hex Keys Set	1.5-2-2.5-3-4-5-6-8-10-12mm	6/24
D2318	9-PC Extra Long Metric Hex Keys Set	1.5-2-2.5-3-4-5-6-8-10mm	6/24



Double Bilster

L-Handle Hex Key

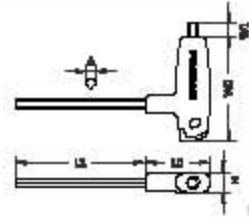

Plastic Card

No.	Size	L0 mm	L1 mm	H mm	W0 mm	W1 mm	A mm	g	Box/Bag
D1002	3x100mm	50	100	16.5	81.5	14	3	12.0	6/98
D1003	4x150mm	50	100	16.5	81.5	14	4	58.0	6/98
D1004	5x150mm	50	150	16.5	81.5	14	5	70.0	6/98
D1005	6x150mm	62.5	150	20.5	101.5	17	6	112.0	6/98
D1006	8x200mm	62.5	200	20.5	101.5	17	8	130.0	6/98
D1007	10x200mm	75	200	24.5	121.5	17	10	200.0	6/80

L-Handle Hex Key With Ball Head

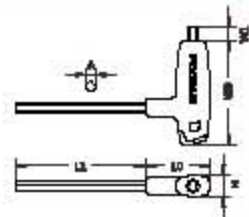

Plastic Card

No.	Size	L0 mm	L1 mm	H mm	W0 mm	W1 mm	A mm	g	Box/Bag
D1108	3x100 mm	50	100	16.5	81.5	14	3	55.0	6/88
D1101	4x150 mm	50	150	16.5	81.5	14	4	70.0	6/88
D1102	5x150 mm	62.5	150	20.5	101.5	17	5	90.0	6/88
D1103	6x150 mm	62.5	150	20.5	101.5	17	6	150.0	6/88
D1104	8x200 mm	62.5	200	20.5	101.5	17	8	220.0	6/88
D1105	10x200 mm	75	200	24.5	121.5	17	10	230.0	6/80

L-Handle Torx Key

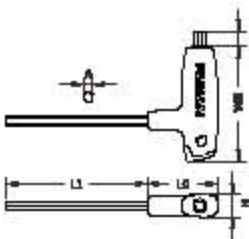

Plastic Card

No.	Size	L0 mm	L1 mm	H mm	W0 mm	W1 mm	A mm	g	Box/Bag
D1201	T10x100 mm	50	100	16.5	81.5	14	5	15.0	6/98
D1202	T15x100 mm	50	100	16.5	81.5	14	6	20.0	6/98
D1203	T20x100 mm	62.5	100	20.5	101.5	17	6	45.0	6/98
D1204	T26x150 mm	62.5	150	20.5	101.5	17	6	60.0	6/98
D1205	T27x150 mm	62.5	150	20.5	101.5	17	6	70.0	6/98
D1206	T30x150 mm	62.5	150	20.5	101.5	17	6	100.0	6/98
D1207	T40x150 mm	62.5	150	20.5	101.5	17	8	120.0	6/98



T-Handle Hex Key

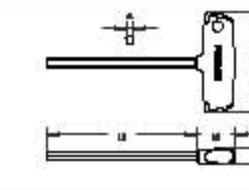

Plastic Card

No.	Size	L0 mm	L1 mm	H mm	W1 mm	A mm	g	Box/Bag
D1301	3x100 mm	30	100	14.5	80	3	55.0	6/98
D1302	4x150 mm	30	150	14.5	80	4	70.0	6/98
D1303	5x150 mm	38	150	16	100	5	90.0	6/98
D1304	6x150 mm	38	150	16	100	6	150.0	6/98
D1305	8x200 mm	38	200	16	100	8	220.0	6/88
D1306	10x200 mm	45	200	18.5	100	10	230.0	6/80

T-Handle Hex Key With Ball Head

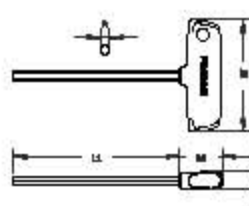

Plastic Card

No.	Size	L0 mm	L1 mm	H mm	W1 mm	A mm	g	Box/Bag
D1401	4x150 mm	30	150	14.5	80	4	55.0	6/88
D1402	5x150 mm	38	150	16	100	5	70.0	6/88
D1403	6x150 mm	38	150	16	100	6	90.0	6/88
D1404	8x200 mm	38	200	16	100	8	150.0	6/88
D1405	10x200 mm	45	200	18.5	120	10	220.0	6/80

T-Handle Torx Key

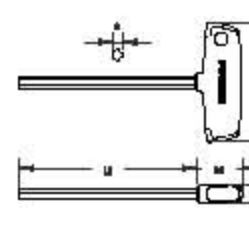

Plastic Card

No.	Size	L0 mm	L1 mm	H mm	W1 mm	A mm	g	Box/Bag
D1501	T10x100 mm	30	100	14.5	80	5	15.0	6/88
D1502	T15x100 mm	30	100	14.5	80	5	20.0	6/88
D1503	T20x100 mm	38	100	18	100	6	45.0	6/88
D1504	T26x150 mm	38	150	18	100	6	60.0	6/88
D1505	T27x150 mm	38	150	18	100	6	70.0	6/88
D1506	T30x150 mm	38	150	18	100	6	100.0	6/88
D1507	T40x150 mm	38	150	18	100	6	120.0	6/88

Pliers

Combination Pliers, Long Nose Pliers, Diagonal Cutting Pliers.....



Industrial Pliers

The unified LOGO section, to achieve a better and longer presentation.

The ergonomic features of series FIXMAN optimized handles for increased comfort. TPR two tone handle, soft and heavy duty.

Industrial quality level, 60CR-V material, forged and fine ground, German style with black finished, Yaws 0.2mm, Jaw gaps 0.25mm.

Suitable for gripping and cutting work in precision mechanics, pointed, serrated gripping surfaces.

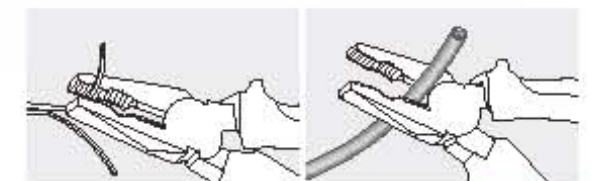

Industrial Combination Pliers

Cr-V
NON-SLIP

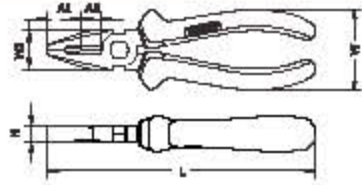

Plastic Card

No.	Size	L mm	H mm	W mm	W1 mm	A1 mm	A2 mm	Weight	Box/Case
A0507	6"	162	10	54	29	22	12	200.0	6/72
A0505	7"	187	10.5	57	27	22.5	16	310.0	6/72
A0506	8"	200	11.5	60	30	25	18	380.0	6/72

Industrial Diagonal Cutting Pliers

Cr-V
NON-SLIP

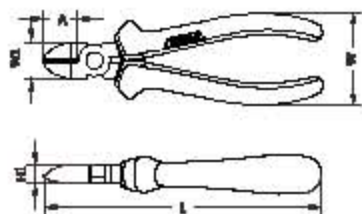

Plastic Card

No.	Size	L mm	H1 mm	W mm	W1 mm	A1 mm	Weight	Box/Case
A0404	6"	170	10.5	60	22.5	22.5	170.0	6/72
A0405	8"	200	11.5	56	25	27	280.0	6/72

Industrial Long Nose Pliers

Cr-V
NON-SLIP

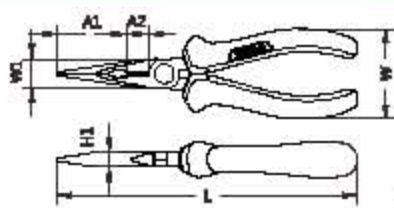

Plastic Card

No.	Size	L mm	H1 mm	W mm	W1 mm	A1 mm	A2 mm	Weight	Box/Case
A0304	6"	185	8.5	58	16.5	40	12	170.0	6/72
A0305	6"	200	9.5	70	18.5	50	11.5	280.0	6/72

Industrial Bent Nose Pliers

Cr-V
NON-SLIP

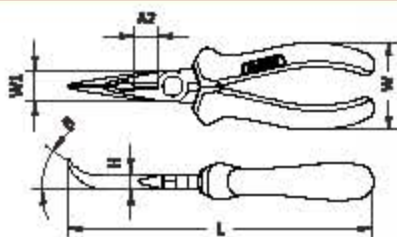

Plastic Card

No.	Size	L mm	H mm	W mm	W1 mm	A2 mm	Weight	Box/Case
A0204	6"	185	8.5	56	18.5	11.5	170.0	6/72
A0205	8"	200	9	56	18.5	12	280.0	6/72

General Pliers

Combination Pliers

NON-SLIP

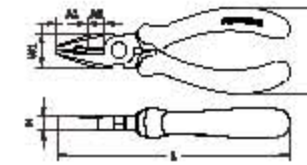

Plastic Card

No.	Size	L mm	H mm	W mm	W1 mm	A1 mm	A2 mm	Weight	Box/Case
A0602	6"	165	10.5	62.5	22	13	7.5	240.0	6/72
A0603	7"	180	11.5	62.5	24.5	16	12.5	310.0	6/72
A0604	8"	210	12	62.5	28.5	13	18	380.0	6/72

Diagonal Cutting Pliers

NON-SLIP

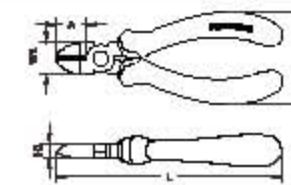

Plastic Card

No.	Size	L mm	H1 mm	W mm	W1 mm	A1 mm	Weight	Box/Case
A0402	6"	165	9.5	65	20.5	22	200.0	6/72
A0403	7.5"	195	10.5	70	22.5	27	265.0	6/72

Long Nose Pliers

NON-SLIP

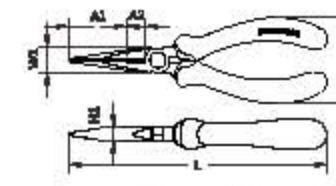

Plastic Card

No.	Size	L mm	H1 mm	W mm	W1 mm	A1 mm	A2 mm	Weight	Box/Case
A0302	6"	185	8.5	62.5	18.5	40	11	170.0	6/72
A0303	8"	205	10.5	70	22	52	12.5	280.0	6/72

Bent Nose Pliers

NON-SLIP

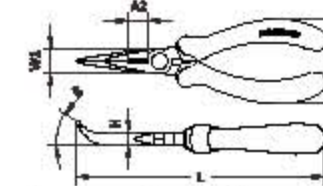

Plastic Card

No.	Size	L mm	H mm	W mm	W1 mm	A2 mm	Weight	Box/Case
A0202	6"	165	8.5	62.5	18.5	12	180.0	6/72
A0203	8"	200	10	65	22	12	280.0	6/72

Wire Stripping Pliers

NON-SLIP

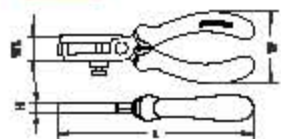

Plastic Card

No.	Size	L mm	H mm	W mm	W1 mm	g	Box/Pack
A1301	6"	165	9.5	62.5	18.5	200.0	6/72

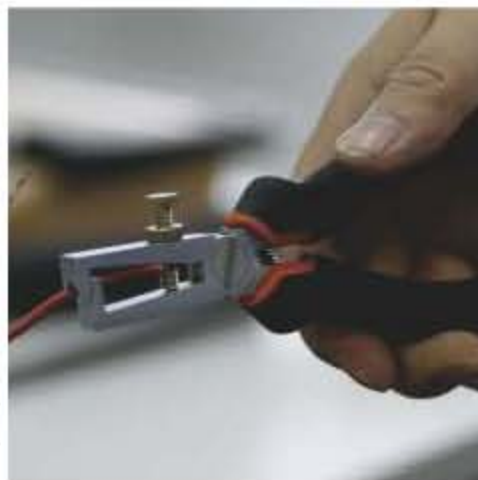

Groove Joint Pliers

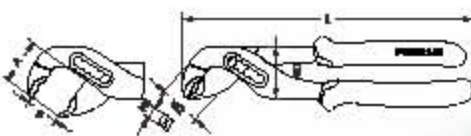

Plastic Card

No.	Size	L mm	H1 mm	W1 mm	W2 mm	A mm	B mm	g	Box/Pack
A1201	8"	200	7	40	30	30	35	280.0	6/72
A1202	10"	260	6.5	42.5	38	36	35	445.0	6/48



Mini Pliers

Combination Pliers

NON-SLIP MINI

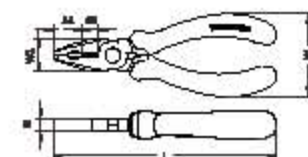

Plastic Card

No.	Size	L mm	H mm	W mm	W1 mm	A1 mm	A2 mm	g	Box/Pack
A0501	4.5"	115	7.5	57	15.5	13	7.5	85.0	6/120



Diagonal Cutting Pliers

NON-SLIP MINI

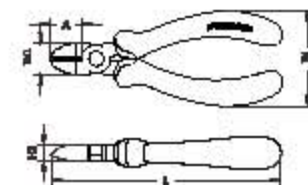

Plastic Card

No.	Size	L mm	H1 mm	W mm	W1 mm	A mm	g	Box/Pack
A0401	4.5"	115	8.5	58	13.5	12	70.0	6/120



Long Nose Pliers

NON-SLIP MINI

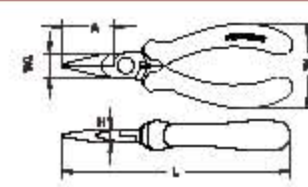

Plastic Card

No.	Size	L mm	H mm	W mm	W1 mm	A mm	g	Box/Pack
A0301	4.5"	125	7	58	12.5	21.5	75.0	6/120



Bent Nose Pliers

NON-SLIP MINI

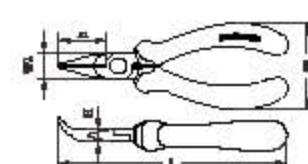

Plastic Card

No.	Size	L mm	H mm	W mm	W1 mm	A mm	g	Box/Pack
A0201	4.5"	125	8	55.5	11.5	12	80.0	6/120



Flat Nose Pliers

NON-SLIP MINI

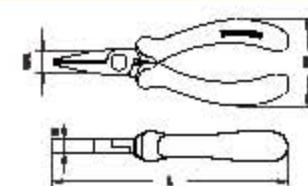

Plastic Card

No.	Size	L mm	H mm	W mm	W1 mm	g	Box/Pack
A0101	4.5"	125	7	55	12	85.0	6/120



Circlip Pliers

Straight-tip Internal Circlip Pliers

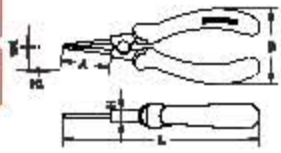

Plastic Card

No.	Size	L mm	H mm	H1 mm	W mm	W1 mm	A mm	g	Box/Case
A0601	6"	155	8	1.5	57	5.5	36.5	185.0	6/72
A0602	7"	175	10	1.75	62.5	5.5	43.5	216.0	6/72

Tip Internal Circlip Pliers

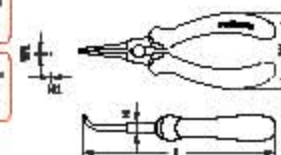

Plastic Card

No.	Size	L mm	H mm	H1 mm	W mm	W1 mm	A mm	g	Box/Case
A0701	6"	145	9.5	1.5	57	4.5	185.0	6/72	
A0702	7"	175	9.5	2	62.5	4.5	210.0	6/72	

Tip Internal Circlip Pliers

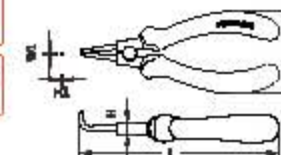

Plastic Card

No.	Size	L mm	H mm	H1 mm	W mm	W1 mm	A mm	g	Box/Case
A0801	6"	145	9.5	1.5	57	4.5	185.0	6/72	
A0802	7"	175	10	2	62.5	4.5	205.0	6/72	

Straight-tip External Circlip Pliers

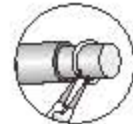
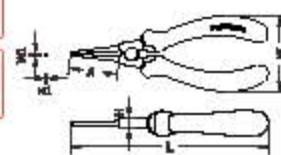

Plastic Card

No.	Size	L mm	H mm	H1 mm	W mm	W1 mm	A mm	g	Box/Case
A0901	6"	145	9	1.5	57	3.5	35	185.0	6/72
A0902	7"	185	10	2	65	4.5	45	215.0	6/72



Tip External Circlip Pliers

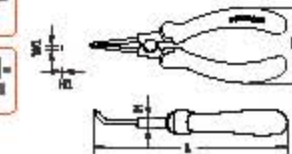

Plastic Card

No.	Size	L mm	H mm	H1 mm	W mm	W1 mm	A mm	g	Box/Case
A1001	6"	145	8.5	1.5	52.5	3.5	180.0	6/72	
A1002	7"	175	9.5	2	65	4.5	210.0	6/72	

Tip External Circlip Pliers

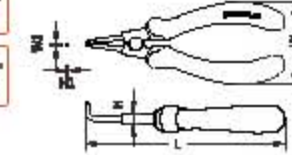

Plastic Card

No.	Size	L mm	H mm	H1 mm	W mm	W1 mm	A mm	g	Box/Case
A1101	6"	145	8.5	1.5	52.5	3.5	180.0	6/72	
A1102	7"	175	9	2	65	4.5	205.0	6/72	

Cable Cutter

Cable Cutter

- Drop forged steel with fully polished;
- Proper heat treatment ensures strong cutting ability, hardness and wearability;
- Notched end for stripping wires;
- For single and multi-strand cables, aluminum and copper cable;
- Maximum cutting range:
A1501: 8mm copper cable.
A1502: 8mm copper cable.

No.	Size	g	Box/Case
A1501	6"	180.0	6/60
A1502	7"	205.0	6/60



Sliding Card



Wire Stripper



Sliding Card

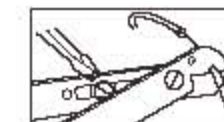

Stripping Wire—Adjust tool by loosening slide screw and positioning stop to point where cutter only penetrates insulation without cutting wire strands.

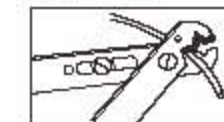

Cutting Wire—Use to cut copper or aluminum wire up to 10 gauge. (Not recommended for hardened wire.)

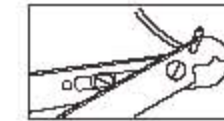

Bending Wire—Insert wire through hole for bending.

Lock-Grip Pliers

Curved Jaw Lock-Grip Pliers

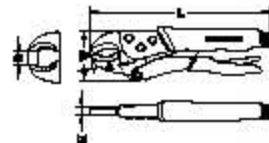

No.	Size	L mm	H mm	W mm	B mm	g	Box/Case
A1403	7"	180	10	50.5	25	180.0	6/72
A1404	10"	225	12.5	85	31.5	580.0	8/36



Half Double Blister

Long Nose Lock-Grip Pliers

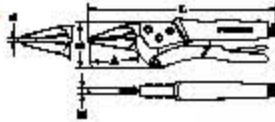

No.	Size	L mm	H mm	A mm	B mm	E mm	g	Box/Case
A1401	8"	165	5	46.5	16.5	38	180.0	6/72
A1402	9"	225	5	55	18.5	52.5	580.0	6/36



Half Double Blister

C-Type Welding Lock-Grip Pliers

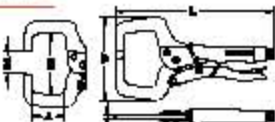

No.	Size	L mm	H mm	W mm	A mm	B1 mm	B2 mm	g	Box/Case
A1408	11"	275	23	137	85	56	119	560	6/24



Half Double Blister

C-Type Welding Lock-Grip Pliers w/Adjustable Tip



No.	Size	L mm	H mm	W mm	A mm	B1 mm	B2 mm	g	Box/Case
A1409	11"	275	23	137	85	55	118	600	6/24



Half Double Blister

Welding Lock-Grip Pliers

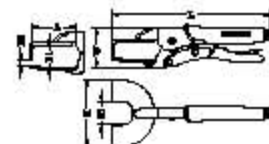

No.	Size	L mm	H mm	H1 mm	W mm	A mm	B1 mm	B2 mm	g	Box/Case
A1405	10"	220	87	22	70	72	31	11.5	580	4/24



Half Double Blister

Flat Lock-Grip Pliers

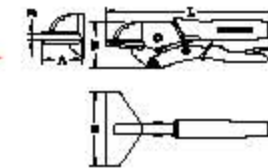

No.	Size	L mm	H mm	W mm	A mm	B mm	g	Box/Case
A1406	10"	245	98	70	45	20	580	3/24



Half Double Blister

Chain Lock-Grip Pliers

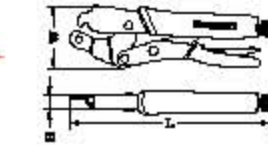

No.	Size	L mm	H mm	W mm	g	Box/Case
A1407	18"	220	19	61.5	580.0	8/24



Half Double Blister

C-Clamp

C-Clamp



No.	Size	g	Box/Case
Q0101	1"	105	6/120
Q0102	2"	200	6/120
Q0103	3"	436	8/48
Q0104	4"	740	8/24
Q0105	5"	760	8/24
Q0106	6"	1105	8/12
Q0107	8"	1810	4/12
Q0108	10"	2585	4/8



Color Card

Hand Riveter

Hand Riveter



• Spring loaded handle ejects rivet stem;
• Rugged steel construction;
• 4 in 1 blocker no need to change the nosepiece.



Sliding Card

No.	Size	g	Box/Case
Q0202	2,4,3,2,4,4,8	516	4/24



Striking Tools

Machinist Hammer, Claw Hammer, Mallet, Punch...

Hammer

High carbon steel, forged and hardened.
Fine finished by polishing.
Jacketed design provides overstrike
Protection for long life and
increased safety.

x3 Buffer

Fiberglass handle absorbs shock and vibration.
TPR two tone grip, soft and heavy duty.
The ergonomic features of series fixman
Optimised handles reduces the effects of
Torque on wrists and elbows.



The unified LOGO section, to achieve a
Better and longer presentation.

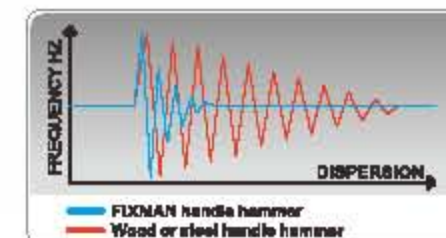

Claw Hammer

NON-SLIP
FINE GRIP

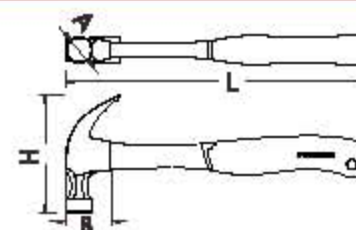

No.	Size	L mm	H mm	A mm	B mm	Weight	Box Qty
C0101	8OZ	286	100	23	39	410.0	4/48
C0102	12OZ	326	122.5	27.5	44	590.0	4/32
C0103	16OZ	386	132	30	48.5	720.0	4/24



Color Label

Rip Claw Hammer

NON-SLIP

FIBRE GRIP

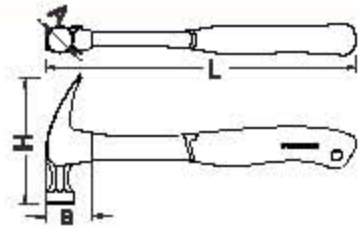

No.	Size	L mm	H mm	A mm	B mm	g	Box/Case
C0401	100Z	300	120	28	38.5	475.0	4/36
C0402	160Z	335	145	30	48.5	750.0	4/24



Color Label

Machinist Hammer

NON-SLIP

FIBRE GRIP

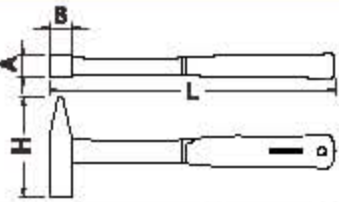

No.	Size	L mm	H mm	A mm	B mm	g	Box/Case
C0201	300g	300	105	23	23	490.0	4/36
C0202	500g	330	115	27.5	27.5	695.0	4/32



Color Label

Ball Pein Hammer

NON-SLIP

FIBRE GRIP

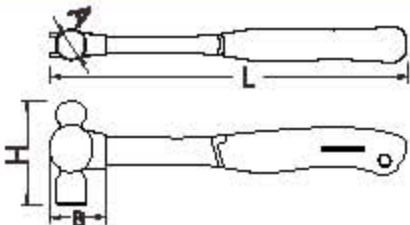

No.	Size	L mm	H mm	A mm	B mm	g	Box/Case
C0301	120Z	320	81	30	42	610.0	4/32
C0302	160Z	325	100	32	45	750.0	4/24



Color Label

Mallet

NON-SLIP

FIBRE GRIP

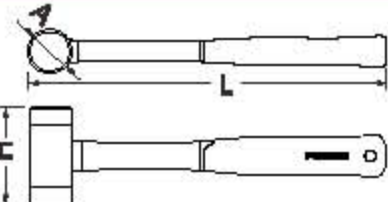

No.	Size	L mm	H mm	A mm	g	Box/Case
C0502	35mm	300	100	35	475.0	4/24



Color Label



Punch & Chisel

Pin Punch

Cr-V

NON-SLIP

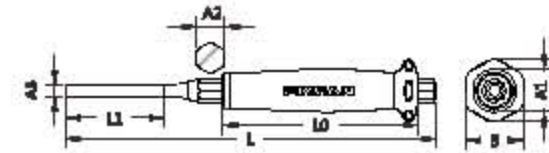

No.	Size	L mm	L0 mm	L1 mm	A mm	A1 mm	A2 mm	A3 mm	B mm	g	Box/Case
M0101	2mm	175	105	25	33.4	23.5	10	2	31.5	130.0	12/96
M0102	3mm	175	105	45	33.4	23.5	10	3	31.5	130.0	12/96
M0103	4mm	175	105	45	33.4	23.5	10	4	31.5	130.0	12/96
M0104	5mm	200	105	65	33.4	23.5	10	6	31.5	135.0	12/96
M0105	6mm	200	105	65	33.4	23.5	10	6	31.5	140.0	12/96
M0106	8mm	200	105	65	33.4	23.5	10	8	31.5	190.0	12/96
M0107	10mm	200	105	65	33.4	23.5	10	10	31.5	205.0	12/96



Plastic Card

Nail Punch

Cr-V

NON-SLIP

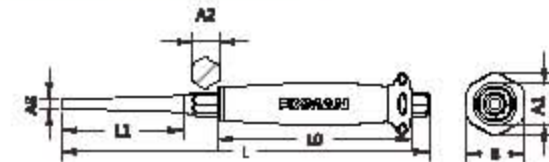

No.	Size	L mm	L0 mm	L1 mm	A mm	A1 mm	A2 mm	A3 mm	B mm	g	Box/Case
M0201	2mm	175	105	45	33.4	23.5	10	2	31.5	135.0	12/96
M0202	3mm	175	105	45	33.4	23.5	10	3	31.5	140.0	12/96
M0203	4mm	175	105	45	33.4	23.5	10	4	31.5	140.0	12/96
M0204	5mm	200	105	60	33.4	23.5	10	5	31.5	150.0	12/96
M0205	6mm	200	105	60	33.4	23.5	10	6	31.5	165.0	12/96



Plastic Card

Center Punch

Cr-V

NON-SLIP

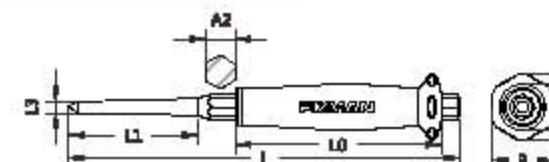

No.	Size	L mm	L0 mm	L1 mm	A mm	A1 mm	A2 mm	A3 mm	B mm	g	Box/Case
M0301	2mm	175	105	45	33.4	23.5	10	2	31.5	135.0	12/96
M0302	4mm	175	105	45	33.4	23.5	10	4	31.5	140.0	12/96
M0303	6mm	200	105	60	33.4	23.5	10	6	31.5	155.0	12/96
M0304	8mm	200	105	60	33.4	23.5	12	8	31.5	205.0	12/96
M0305	10mm	200	105	60	33.4	23.5	12	10	31.5	220.0	12/96



Plastic Card

Flat Chisel

Cr-V
NON-SLIP

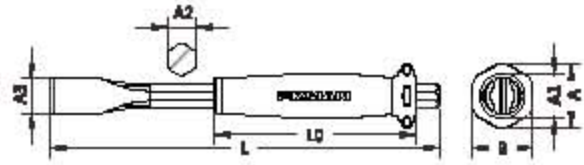

No.	Size	L mm	LO mm	A mm	A1 mm	A2 mm	A3 mm	B mm	g	Box/Case
M0501	12mm	200	105	33.4	23.5	10	12	31.5	125.0	12/98
M0502	15mm	200	105	33.4	23.6	10	15	31.5	165.0	12/98
M0503	18mm	200	106	33.4	23.6	12	18	31.5	215.0	12/98



Cape-Chisel

Cr-V
NON-SLIP

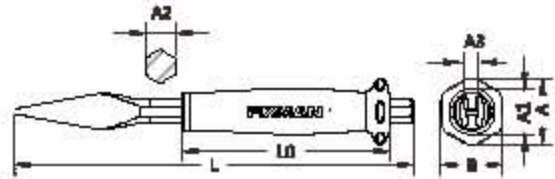

No.	Size	L mm	LO mm	A mm	A1 mm	A2 mm	A3 mm	B mm	g	Box/Case
M0401	6mm	200	105	33.4	23.5	12	6.7	31.5	205.0	12/98



Wood Working Chisel

Cr-V
NON-SLIP

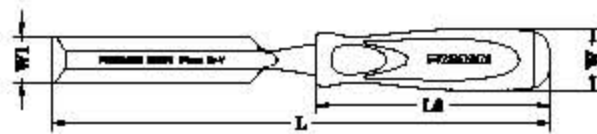

METRIC No.	SAE No.	S mm	S Inch	L mm	LO mm	W mm	W1 mm	g	Box/Case
M0601	M0612	6mm	1/4"	275	135	35	6	165	6/24
M0602	/	8mm	/	276	136	35	8	170	6/24
M0603	M0613	10mm	3/8"	276	136	35	10	180	6/24
M0604	/	12mm	/	276	136	35	12	180	6/24
M0605	M0616	16mm	5/8"	276	136	35	14	200	6/24
M0606	/	18mm	/	276	136	35	16	210	6/24
M0607	/	20mm	/	275	135	35	18	210	6/24
M0608	M0617	25mm	1"	275	135	35	20	230	6/24
M0609	M0618	32mm	1-1/4"	275	135	35	25	260	6/24
M0610	M0619	35mm	1-1/2"	276	136	35	32	270	6/24
M0611	/	50mm	/	276	136	35	38	340	6/24



Cold chisel with BI-Material Hand Guard

Cr-V
NON-SLIP

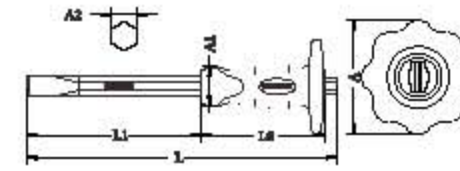

No.	Size	L mm	LO mm	L1 mm	A mm	A1 mm	A2 mm	g	Box/Case
M0701	8"	200	118	70	94	38	18	460	6/24
M0702	10"	250	118	120	94	38	18	570	6/24
M0703	12"	300	120	168	94	38	18	650	6/24



Point chisel with BI-Material Hand Guard

Cr-V
NON-SLIP

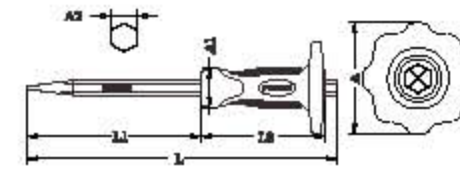

No.	Size	L mm	LO mm	L1 mm	A mm	A1 mm	A2 mm	g	Box/Case
M0801	8"	200	118	70	94	38	18	470	6/24
M0802	10"	250	118	120	94	38	18	660	6/24
M0803	12"	300	120	168	94	38	18	640	6/24



Cold chisel

Cr-V

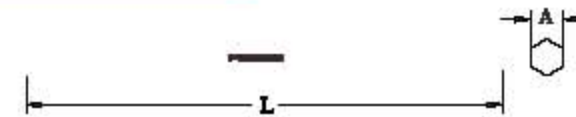

No.	Size	L mm	A mm	g	Box/Case
M1001	8"	150	16	230	6/24
M1002	8"	200	16	320	6/24
M1003	10"	250	16	410	6/24
M1004	12"	300	16	485	6/24



Point chisel

Cr-V



No.	Size	L mm	A mm	g	Box/Case
M0901	8"	150	16	215	6/24
M0902	8"	200	16	305	6/24
M0903	10"	250	16	390	6/24
M0904	12"	300	16	475	6/24



Cutting Tools

Knife, Snips, File, Spatula, Scraper, Hacksaw...



Knife

Snap Off Knife

SELF-LOCK

NON-SLIP

SK5

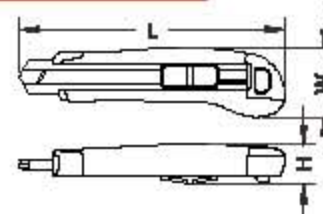

Plastic Card

No.	Size	L mm	H mm	W mm	kg	Box
E0101	18mm Blade x 3pcs	185	25.8	42	120.0	6/120

Snap Off Knife

SELF-LOCK

NON-SLIP

SK5



Skin Card

No.	Size	L mm	H mm	W mm	kg	Box
E0103	18mm Blade x 1pc	150	20	41	65	6/120

Snap Off Knife Blade

SK5

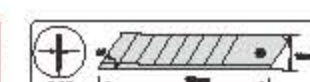

No.	Size	L mm	kg	Box
E0102	18mm Blade x 10pcs	185	7	20/200

Retractable Utility Knife

SELF-LOCK

NON-SLIP

SK5

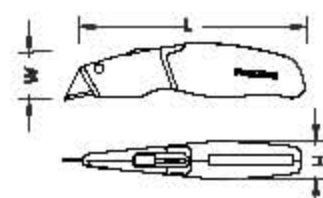

Plastic Card

No.	Size	L mm	H mm	W mm	kg	Box
E0201	18mm Blade x 5pcs	170	28.5	35	125.0	6/120

Retractable Utility Knife Blade

SK5

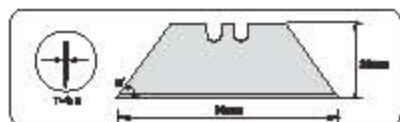

No.	Size	L mm	g	Box/Pack
E0202	18mm Blade x 10pcs	80	4	20/200



Snap Off Knife

SELF-LOCK

NON-SLIP

SK5

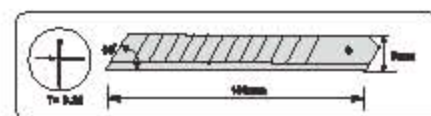

No.	Size	L mm	H mm	W mm	g	Box/Pack
E0110	8mm Blade x 1pc	138	10	11.6	20	12/120



Skin Card

Snap Off Knife Blade

SK5

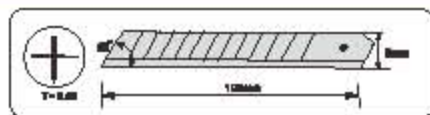

No.	Size	L mm	g	Box/Pack
E0111	9mm Blade x 10pcs	138	4	20/200



File

Steel File-Half Round

NON-SLIP

T12 STEEL



No.	Size	L mm	L0 mm	L1 mm	H mm	W mm	A mm	B mm	g	Box/Pack
F0102	8"	310	110	200	23	35	20	5.5	185.0	6/72
F0103	10"	360	110	250	23	35	24	7	205.0	6/80
F0104	12"	420	120	300	27	40	28	9	315.0	6/48



Plastic Card

Steel File-Round

NON-SLIP

T12 STEEL

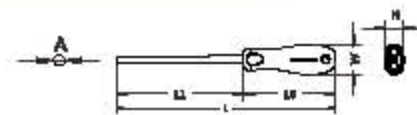

No.	Size	L mm	L0 mm	L1 mm	H mm	W mm	A mm	g	Box/Pack
F0202	8"	310	110	200	23	35	7.5	130.0	6/72
F0203	10"	360	110	250	23	35	8	185.0	6/80
F0204	12"	420	120	300	27	40	12	235.0	6/48



Plastic Card

Steel File-Triangle

NON-SLIP

T12 STEEL



No.	Size	L mm	L0 mm	L1 mm	H mm	W mm	A mm	B mm	g	Box/Pack
F0302	8"	310	110	200	23	35	12	10.4	135.0	6/72
F0303	10"	360	110	250	23	35	15	13	200.0	6/80
F0304	12"	420	120	300	27	40	18	16.8	315.0	6/48



Plastic Card

Steel File-Square

NON-SLIP

T12 STEEL



No.	Size	L mm	L0 mm	L1 mm	H mm	W mm	A mm	g	Box/Pack
F0402	8"	310	110	200	23	35	7.5	130.0	6/72
F0403	10"	360	110	250	23	35	8	185.0	6/80
F0404	12"	420	120	300	27	40	12	235.0	6/48



Plastic Card

Steel File-Flat

NON-SLIP

T12 STEEL

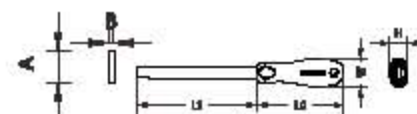

No.	Size	L mm	L0 mm	L1 mm	H mm	W mm	A mm	B mm	g	Box/Pack
F0502	8"	310	110	200	23	35	22	4	180.0	6/72
F0503	10"	360	110	250	23	35	24	6	185.0	6/80
F0504	12"	420	120	300	27	40	28	6	316.0	6/48



Plastic Card

Wood File-Flat

NON-SLIP

T12 STEEL

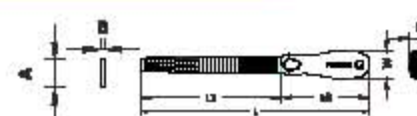

No.	Size	L mm	L0 mm	L1 mm	H mm	W mm	A mm	B mm	g	Box/Pack
F0602	8"	310	110	200	23	35	21	5.6	180.0	6/72
F0603	10"	360	110	250	23	35	25	7	185.0	6/80
F0604	12"	420	120	300	27	40	30	9	316.0	6/48



Plastic Card

Snips

Tin Snips

LEFT CUT
Cr-V

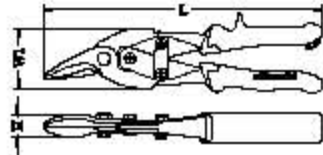

Half Double Bilster

No.	Size	L mm	H mm	W1 mm	W2 mm	g	Box/Case
E0301	250mm	260	17	58	480.0		6/36

STANDARD CUT
Cr-V

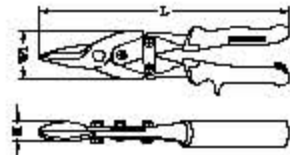

Half Double Bilster

No.	Size	L mm	H mm	W1 mm	W2 mm	g	Box/Case
E0302	250mm	260	17	58	480.0		6/36

RIGHT CUT
Cr-V

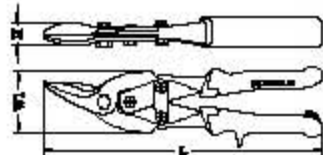

Half Double Bilster

No.	Size	L mm	H mm	W1 mm	W2 mm	g	Box/Case
E0303	250mm	260	17	58	480.0		6/36

Spatula

Spatula W/Pear Wood Handle

STAINLESS STEEL

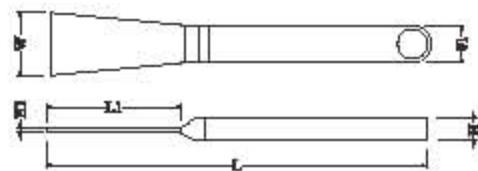

Color Label

No.	Size	L mm	L1 mm	W mm	W1 mm	H mm	H1 mm	g	Box/Case
E0401	1"	235	123	25	20	17	1	75	6/120
E0402	1.5"	235	123	38	20	17	1	80	6/120
E0403	2"	235	117	50	20	17	1	85	6/120
E0404	2.5"	235	117	63	20	17	1	85	6/120
E0405	3"	235	117	75	20	17	1	90	6/120
E0406	4"	235	117	100	20	17	1	95	6/120

Scraper

SKS

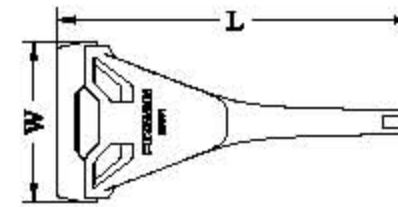

Color Card

No.	Size	L mm	W mm	g	Box/Case
E0501	18mm	75	65	25	12/96

Hacksaw

High Tension Hacksaw

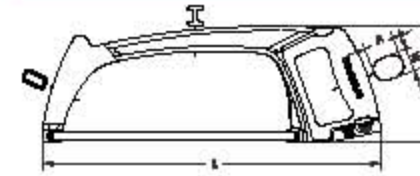

-Easy open lever for quick and easy blade change.
-High tension blade for straight accurate cuts.



No.	Size	L mm	H mm	W mm	A mm	g	Box/Case
K0201	12"	415	140	28	37	725.0	4/24



Color Label

Composite Hacksaw

-Easy open lever for quick and easy blade change.
-High tension blade for straight accurate cuts.

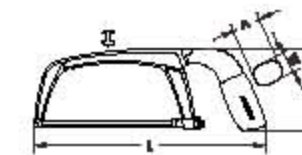

No.	Size	L mm	H mm	W mm	A mm	g	Box/Case
K0101	8"	250	87.5	26	32	185.0	6/72



Color Label

100-pc Saw Blade Set

ISS

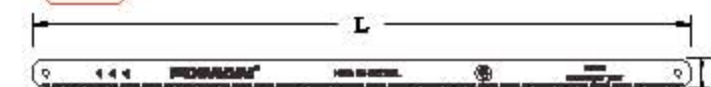

No.	Size	L mm	W mm	g	Box/Case
K0301	18Teeth	300	12	15	1/6
K0302	24Teeth	300	12	15	1/6
K0303	32Teeth	300	12	15	1/6





Measuring Tools

Measuring Tape, Square

Measuring Tape



Durable blade with special coating

Clear and gradual graduation

Movable lip allows to measure internal and external diameters

Top flexible operation of the blade



Plastic Card

No.	Size	H mm	A mm	B mm	W	W/P
G0101	3m/10FT	80	75	33.5	130.0	6/72
G0102	5m/16FT	70	85	41	215.0	6/80
G0103	7.5m/26FT	88	100	43.5	330.0	6/48

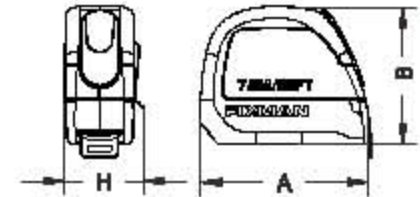

Measuring Tape

No.	Size	W	W/P
G0401	3M X 18mm	110	6/72
G0402	5MX 18mm	200	6/80
G0403	7.6M X 25mm	300	6/48



Double Bitster

Square



No.	Size	W/P
G0201	200x300mm	6/48
G0202	400x600mm	6/24

Flanged Square



No.	Size	W/P
G0301	6"	6/48
G0302	8"	6/48
G0303	10"	6/48
G0304	12"	6/48

A	
Code	Page
A0101	74
A0201	74
A0202	72
A0203	72
A0204	71
A0205	71
A0301	74
A0302	72
A0303	72
A0304	71
A0305	71
A0401	74
A0402	72
A0403	72
A0404	71
A0405	71
A0501	74
A0502	72
A0503	72
A0504	72
A0505	71
A0506	71
A0507	71
A0601	75
A0602	75
A0701	75
A0702	75
A0801	75
A0802	75
A0901	75
A0902	75
A1001	76
A1002	76
A1101	76
A1102	76
A1201	73
A1202	73
A1301	73
A1401	77
A1402	77
A1403	77
A1404	77
A1405	77
A1406	78
A1407	78
A1408	77
A1409	77
A1501	76
A1502	76
A1601	76

B	
Code	Page
B0101	52
B0102	52
B0103	52
B0201	53
B0202	53
B0203	53
B0204	53
B0205	53
B0206	53
B0207	53
B0208	53
B0209	53
B0210	53
B0211	53
B0212	53
B0213	53
B0214	53
B0215	53
B0216	53
B0217	53
B0218	53
B0219	53
B0220	53
B0221	53
B0222	53
B0223	53
B0224	53
B0225	53
B0237M	36
B0301	54
B0302	54
B0303	54
B0304	54
B0305	54
B0306	54
B0307	54
B0308	54
B0309	54
B0310	54
B0401	54
B0402	54
B0403	54
B0404	54
B0405	54
B0406	54
B0407	54
B0408	54
B0409	54
B0410	54
B1001	55

B1002	55
B1003	55
B1004	55
B1005	55
B2042M	36
B3020M	36
B4025M	28
B5079M	29
B5095M	30
B5106M	27
B5111	31
BT111	25
BT120	22
BT124	26
BT40	35
BT46	33
BT65	34
BT70	32
BT72	23
BT84	24

C	
Code	Page
C0101	80
C0102	80
C0103	80
C0201	81
C0202	81
C0301	81
C0302	81
C0401	81
C0402	81
C0502	81
C1NP4	6
C1RP4	6

D	
Code	Page
D0101	58
D0102	58
D0103	58
D0104	58
D0105	58
D0106	58
D0107	58
D0108	58
D0109	58
D0110	58
D0111	58
D0112	58
D0113	58
D0114	58

D0115	58
D0201	58
D0202	58
D0203	58
D0204	58
D0205	58
D0206	58
D0207	58
D0208	58
D0209	58
D0210	58
D0211	58
D0212	58
D0213	58
D0214	58
D0215	58
D0216	58
D0301	59
D0302	59
D0303	59
D0401	59
D0402	59
D0403	59
D0404	59
D0405	59
D0406	59
D0407	59
D0501	61
D0502	61
D0601	61
D0701	61
D0801	60
D0802	60
D0803	60
D0804	60
D0805	60
D0808	60
D0901	60
D0902	60
D0903	60
D1002	67
D1003	67
D1004	67
D1005	67
D1006	67
D1007	67
D1101	67
D1102	67
D1103	67
D1104	67
D1105	67
D1106	67

D1201	67
D1202	67
D1203	67
D1204	67
D1205	67
D1206	67
D1207	67
D1301	68
D1302	68
D1303	68
D1304	68
D1305	68
D1306	68
D1401	68
D1402	68
D1403	68
D1404	68
D1405	68
D1501	68
D1502	68
D1503	68
D1504	68
D1505	68
D1506	68
D1507	68
D1601	60
D1602	60
D1603	60
D1604	60
D1701	60
D1702	60
D1703	60
D1704	60
D1705	60
D1706	60
D1801	59
D1802	59
D1803	59
D1804	59
D1805	59
D1806	59
D1807	59
D1808	59

E	
Code	Page
E0101	86
E0102	86
E0103	86
E0110	87
E0111	87
E0201	86

E0202	87
E0301	89
E0302	89
E0303	89
E0401	89
E0402	89
E0403	89
E0404	89
E0405	89
E0406	89
E0601	90

F	
Code	Page
F0102	87
F0103	87
F0104	87
F0202	88
F0203	88
F0204	88
F0302	88
F0303	88
F0304	88
F0402	88
F0403	88
F0404	88
F0502	88
F0503	88
F0504	88
F0602	88
F0603	88
F0604	88
F1.A1	7
F1.A2	7
F1.A3	7
F1.A3-2	8
F1.A4	8
F1.A5	8
F1.A6	8
F1.A6B	8
F1.BT05.1	18
F1.BT05.2	17
F1.BT06.1	17
F1.BT07	19
F1.BT11	18
F1.BT12	18
F1.BT23	17
F1.BT24	18
F1.BT25	18
F1.BT26	18
F1.BT27	17
F1.BT27	18

F1.BT30	18
F1.BT31	18
F1.BT32	18
F1.BT35	16
F1.BT36	16
F1.BT37	16
F1.BT47	17
F1.BT48	16
F1.BT49	16
F1.BT53	18
F1.BT55	17
F1.BT60	17
F1.BT61	17
F1.BT62	17
F1.BT63	17
F1.BT64	16
F1.BT70	16
F1.BT71	16
F1.BT72	16
F1.BT73	16
F1.BT74	17
F1.BT75	17
F1.BT76	16
F1.BT79	16
F1.BT83	18
F1RP.S	5
F1RP1	5
F1RP10	4
F1RP4	5
F1RP4B	5
F1RP6	3
F1RP6.C6	6
F1RP7	4
F1RP7B	4
F1RP8	4
F2.BT28	19
F3.BT80	19
F4.BT13	19
F5.BT52	19
F6.BT38	19
F7.BT39	19

G	
Code	Page
G0101	92
G0102	92
G0103	92
G0201	92
G0202	92
G0301	92
G0302	92
G0303	92

G0304	92
G0401	92
G0402	92
G0403	92

H	
Code	Page
H0101M	40
H0102M	40
H0103M	40
H0104M	40
H0105M	40
H0106M	40
H0107M	40
H0108M	40
H0109M	40
H0110M	40
H0111M	40
H0112M	40
H0113M	40
H0201M	41
H0202M	41
H0203M	41
H0204M	41
H0205M	41
H0206M	41
H0207M	41
H0208M	41
H0209M	41
H0210M	41
H0211M	41
H0212M	41
H0213M	41
H0214M	41
H0215M	41
H0216M	41
H0217M	41
H0301M	42
H0302M	42
H0303M	42
H0304M	42
H0305M	42
H0306M	42
H0307M	42
H0308M	42
H0309M	42
H0310M	42
H0311M	42
H0312M	42
H0313M	42
H0314M	42
H0315M	42

H0316M	42
H0317M	42
H0318M	42
H0319M	42
H0320M	42
H0321M	42
H0401M	40
H0402M	40
H0403M	40
H0404M	40
H0405M	40
H0406M	40
H0407M	40
H0408M	40
H0409M	40
H0410M	40
H0411M	40
H0501M	42
H0502M	42
H0503M	42
H0504M	42
H0505M	42
H0506M	42
H0507M	42
H0508M	42
H0509M	42
H0510M	42
H0511M	42
H0512M	42
H0513M	42
H0514M	42
H0515M	42
H0516M	42
H0601M	43
H0602M	43
H0603M	43
H0604M	43
H0605M	43
H0606M	43
H0607M	43
H0608M	43
H0609M	43
H0610M	43
H0611M	43
H0612M	43
H0613M	43
H0614M	43
H0615M	43
H0616M	43
H0617M	43
H0618M	43
H0701M	40

H0702M	40
H0703M	40
H0704M	40
H0705M	40
H0801M	41
H0802M	41
H0803M	41
H0804M	41
H0805M	41
H0806M	41
H0807M	41
H0808M	41
H0809M	41
H0810M	41
H0811M	41
H0812M	41
H0901M	43
H0902M	43
H0903M	43
H0904M	43
H0905M	43
H0906M	43
H0907M	43
H0908M	43
H0909M	43

J	
Code	Page
J0101	39
J0102	39
J0103	39
J0201	47
J0301	46
J0302	46
J0303	46
J0304	46
J0305	46
J0306	46
J0307	46
J0308	46
J0309	46
J0401	47
J0402	47
J0403	47
J0501	47
J0502	47
J0503	47
J0504	47
J0601	47
J0602	47
J0603	47
J0604	47

J0101	39
J0102	39
J0103	39
J0201	47
J0301	46
J0302	46
J0303	46
J0304	46
J0305	46
J0306	46
J0307	46
J0308	46
J0309	46
J0401	47
J0402	47
J0403	47
J0501	47
J0502	47
J0503	47
J0504	47
J0601	47
J0602	47
J0603	47
J0604	47
J0605	47
J0606	47
J0701	47
J0702	47
J0703	47
J0704	47
J0705	48
J0801	44
J0802	44
J0803	44
J0804	44
J0805	44
J0806	44
J0807	44
J0808	44
J0809	44
J0810	44
J0811	44
J0812	44
J0813	43
J0814	43
J0815	43
J0816	44
J0817	44
J0818	44
J0819	44
J0820	44
J0821	44

J0822	44
J0823	44
J0901	45
J0902	45
J0903	45
J0904	45
J0905	45
J0906	45
J0907	45
J0908	45
J0909	45
J0910	45
J0911	46
J0912	46
J0913	46
J0914	46
J0915	46
J0916	46
J0917	46
J0918	46
J0919	46
J0920	46
J0921	46
J0922	46
J0923	46
J0924	45
J0925	45
J0926	45
J0927	45
J0928	45
J0929	45
J0930	45
J0931	45
J0932	45
J0933	45
J0934	45
J0935	45
J0936	45
J0937	45
J0938	45
J1001	48
J1002	46
J1003	46
J1004	46
J1005	46
J1006	46
J1101	48
J1102	48
J1103	48
J1201	48
J1202	48
J1203	48

K	
Code	Page
K0101	90
K0201	90
K0301	90
K0302	90
K0303	90

M	
Code	Page
M0101	82
M0102	82
M0103	82
M0104	82
M0105	82
M0106	82
M0107	82
M0201	82
M0202	82
M0203	82
M0204	82
M0205	82
M0302	82
M0303	82
M0304	82
M0401	83
M0501	83
M0502	83
M0503	83
M0601	83
M0602	83
M0603	83
M0604	83
M0605	83
M0606	83
M0607	83
M0608	83
M0609	83
M0610	83
M0611	83
M0701	84
M0702	84
M0703	84
M0801	84
M0802	84
M0803	84
M0901	84
M0902	84
M0903	84
M0904	84
M1001	84
M1002	84

M1003	84
M1004	84
MT19	37
MT20	37
MT22	37
MT26	37

N	
Code	Page
N3000	62
N3001	62
N3002	62
N3003	62
N3004	62
N3100	62
N3101	62
N3102	62
N3103	62
N3104	62
N3201	62
N3202	62
N3203	62
N3204	62
N3301	62
N3302	62
N3303	62
N3304	62
N3401	62
N3402	62
N3403	62
N3404	62
N3405	62
N3406	62
N3407	62
N3501	62
N3502	62
N3503	62
N3504	62
N3505	62
N3506	62
N3507	62
N3601	62
N3602	62
N3603	62
N3604	62
N3701	62
N3702	62
N3703	62
N3704	62
N3801	63
N3802	63
N3803	63

N3804	63
N3901	63
N3902	63
N3903	63
N3904	63
N4001	63
N4002	63
N4003	63
N4004	63
N4101	63
N4102	63
N4103	63
N4104	63
N4201	63
N4202	63
N4203	63
N4204	63
N4205	63
N4301	63
N4302	63
N4303	63
N4304	63
N4305	63
N4401	63
N4402	63
N4403	63
N4404	63
N4405	63
N4406	63
N4407	63
N4408	63
N4501	63
N4502	63
N4503	63
N4504	63
N4505	63
N4506	63
N4507	63
N4508	63
N4601	63
N4602	63
N4603	63
N4604	63
N4605	63
N4701	63
N4702	63
N4703	63
N4704	63
N4705	63
N4801	62
N4802	62
N4803	62

N4804	62
N4805	62
N4901	62
N4902	62
N4903	62
N4904	62
N4905	62

P	
Code	Page
P2008M	49
P3009M	49
P4010M	49
P4012M	50
P4019M	50

Q	
Code	Page
Q0101	78
Q0102	78
Q0103	78
Q0104	78
Q0105	78
Q0106	78
Q0107	78
Q0108	78
Q0202	78

W	
Code	Page
W1RM10	10
W1RM6	9
W1RM7	9
W1RM7B	9
W1RM8	10
W2RM10	11
W2RM6	10
W2RM7	10
W2RM7B	11
W2RM8	11
W3RM10	12
W3RM6	11
W3RM7	12
W3RM7B	12
W3RM8	12

Z	
Code	Page
Z0101	14
Z0102	14
Z200	13
Z201	13

Z202	13
Z807	13
Z808	13

FIXMAN Color



Packing Guide



Remarks

This catalog cancels and replaces all previous editions.
 No part of this catalogue may be reproduced without the prior written consent of us.
 We reserves the right to modify models and assortments shown in this catalogue in order to upgrade them or for any commercial and/or technical reasons without any obligation to advise on models sold previously.
 We reserves the right to withdraw from date, for any technical and/or commercial reasons, any model from this catalogue without notice.
 All figures referring to model weights, sizes and performance in the catalogue are approximate and might be modified.
 Actual dimensions of models might vary from the illustrations in this catalogue.